

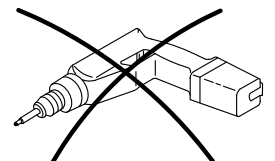

# ASSEMBLY INSTRUCTIONS

## BONDI OUTDOOR FURNITURE COLLECTION

Please read instructions carefully. Remove all wrapping material and packing from the carton. See hardware and furniture parts list for guidance. Be sure you have all parts before you start to assemble the product. Place all furniture parts on a clean surface, such as carpet or rug to prevent the item from being scratched.

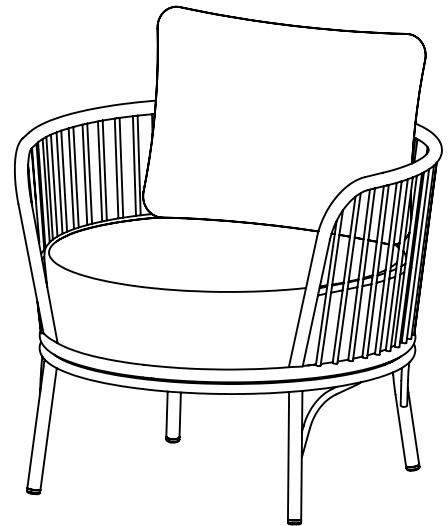
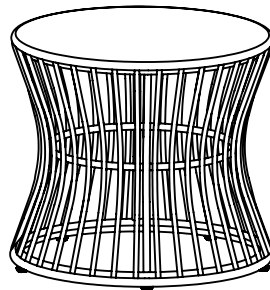
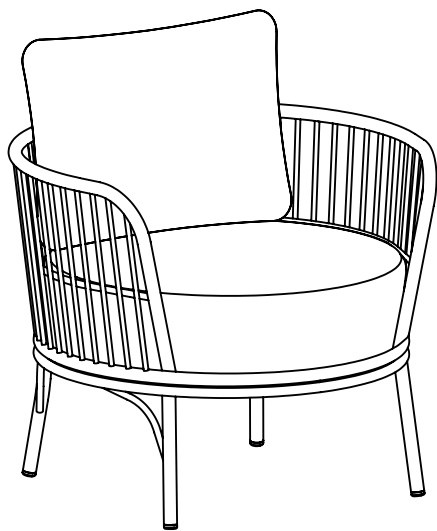
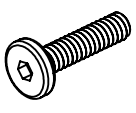

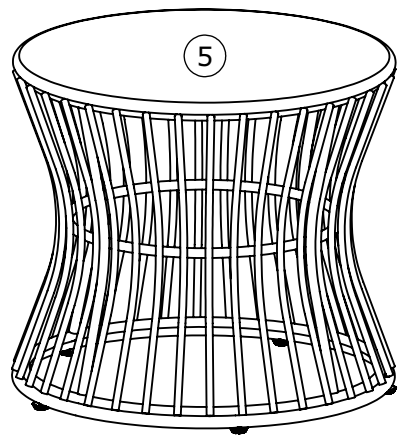
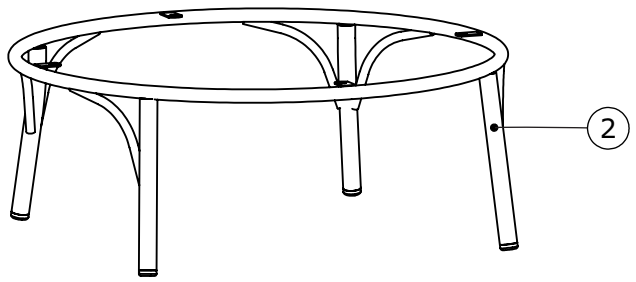
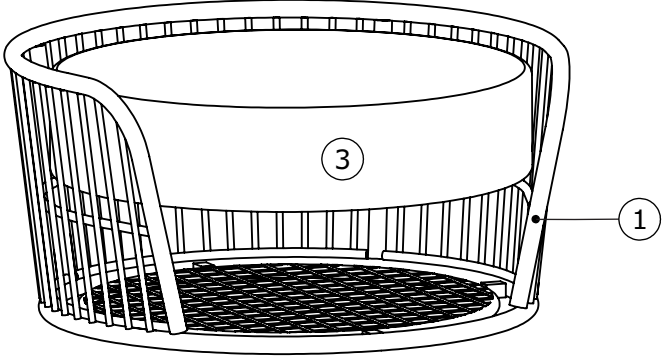
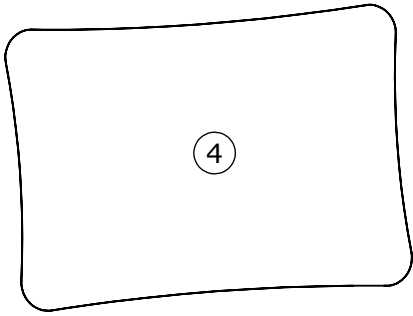

A x 8  M6x25 mm	B x 8  Ø16x1 mm	C x 2  4 mm
--	--	--



⑤ x 1
④ x 2
③ x 2
② x 2
① x 2

1

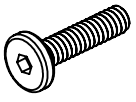
x2

<p>A x 4</p>  <p>M6x25 mm</p>	<p>B x 4</p>  <p>Ø16x1 mm</p>	<p>C x 1</p>  <p>4 mm</p>
--	--	--

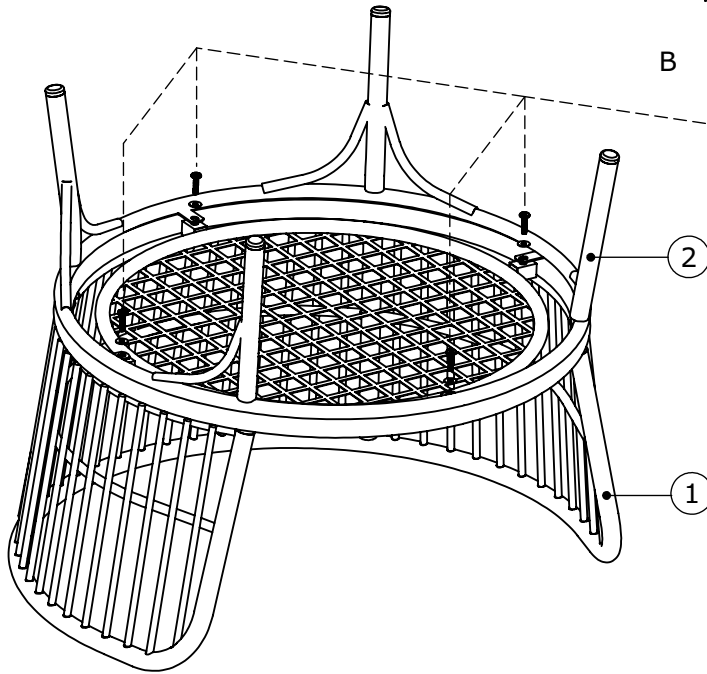
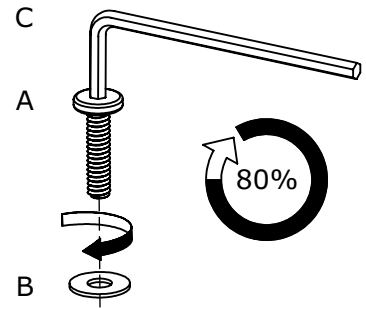

2

x2

