

ASSEMBLY INSTRUCTIONS DALLAS BEDSIDE TABLE

Please read instructions carefully. Remove all wrapping material, staples and packing straps from the carton. See hardware and furniture parts list for guidance. Be sure you have all parts before you start assembling. Place all wooden furniture parts on a clean flat soft surface, such as carpet or rug to prevent from being scratched.

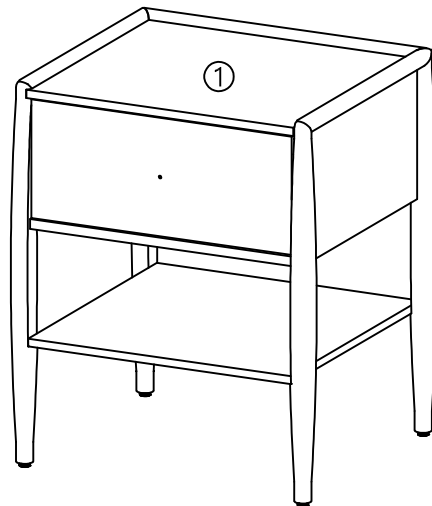

PARTS INCLUDED

1. Bedside : 1pc

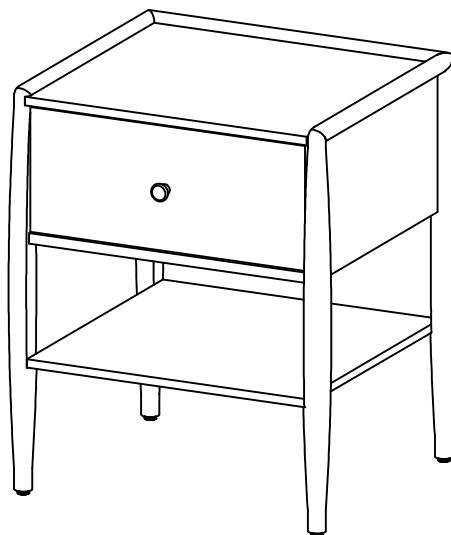

HARDWARE LIST

A. Screw : 1pc
B. Rawl plug : 1pc

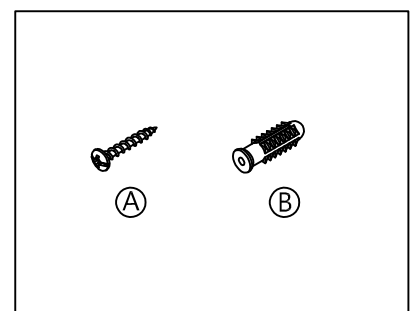

FOR ASSEMBLY

- First, check the contents to make sure that nothing is missing.
- Sort out the parts and fittings as shown, assemble product step by step.
- It is preferable to rest the product on a soft surface to avoid damage during assembly.
- Do not overtighten screws and fittings.
- Re-tighten all screws and fittings periodically.

ASSEMBLY INSTRUCTIONS DALLAS BEDSIDE TABLE

adairs

STEP 1

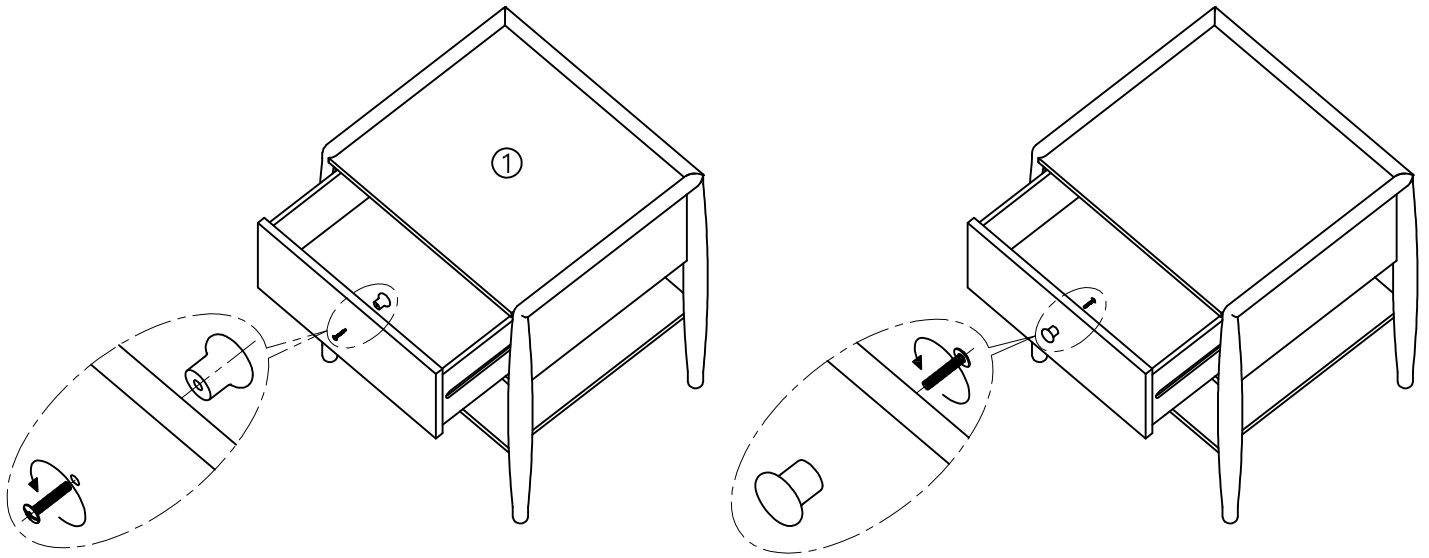

STEP 2

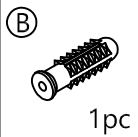
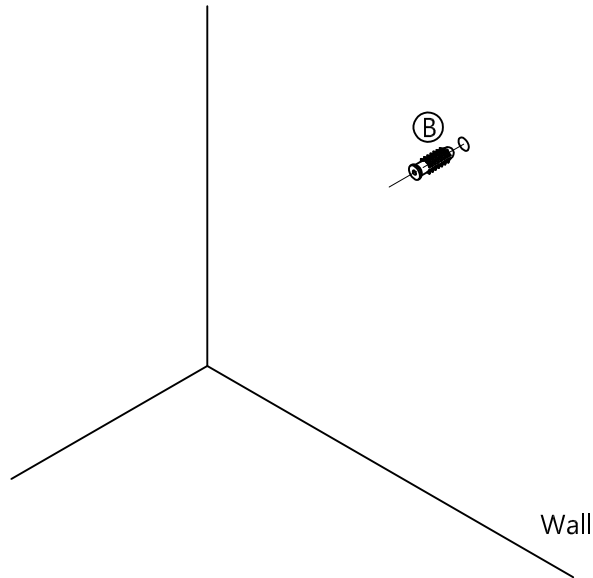

STEP 3

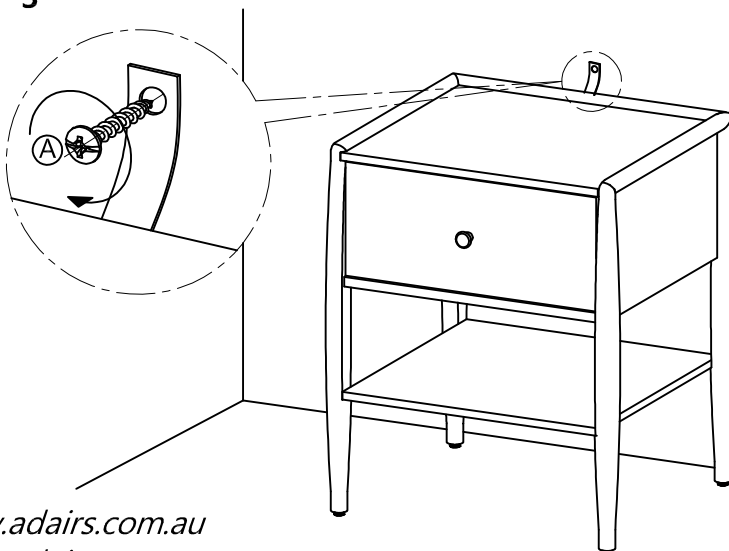

Please note stoppers on base of feet can be tightened or loosened for placement on uneven surfaces.

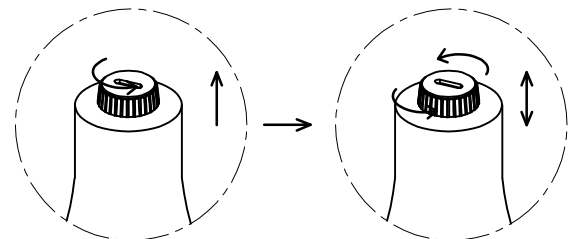

www.adairs.com.au
www.adairs.co.nz

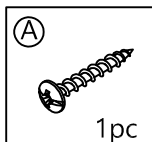

ASSEMBLY INSTRUCTIONS

DALLAS BEDSIDE TABLE

adairs

WARNING:

It is **STRONGLY RECOMMENDED** that you **ANCHOR** this product.

Toppling furniture can cause serious injuries and death.

This product has been fitted with an anchor strap.

To prevent your furniture from tipping forward it is strongly recommended that you **securely attach this product** to a wall or other solid surface, using the anchor strap provided and appropriate fixings.

IMPORTANT:

Regularly check that anchors are securely maintained.

Use safety **drawer locks** to prevent children climbing.

Stability of tall items may be affected by thick pile carpet or uneven floors.

Do not place unanchored televisions on furniture.

CAUTION:

For your safety when attaching the anchor fixings, please note the following:

- Check for any electrical wires or plumbing inside the wall before drilling any holes (if you are unsure please seek professional advice from a qualified tradesperson)
- Walls are constructed from different materials, for example, masonry (solid brick) or plasterboard lined cavity walls (hollow). It is important that you use the appropriate wall fixings for your wall type.
- Your local hardware store will have the necessary drills and fixings and can offer advice if needed. If in doubt, engage the services of a qualified tradesperson to install and anchor the product.